

Standard, Armless & Ottomans (All 4 seat items ship as one piece if stationary, two pieces if motion installed)

Put Green Arrows with Red Arrows to Create Sectional Groups → ←

Put Blue Arrows with Yellow Arrows to Create Sectional Groups → ← or Green Arrows with Red Arrows → ← to mix with some of the L-Shaped pieces.

2 Piece Curve Sectional & Ottomans

v.03.09.15

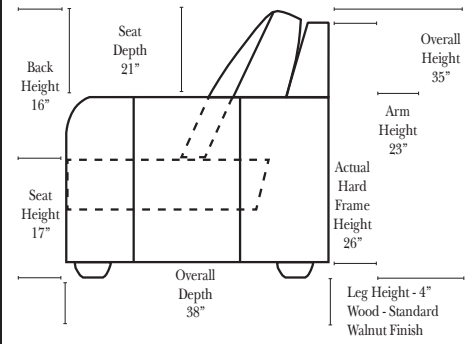
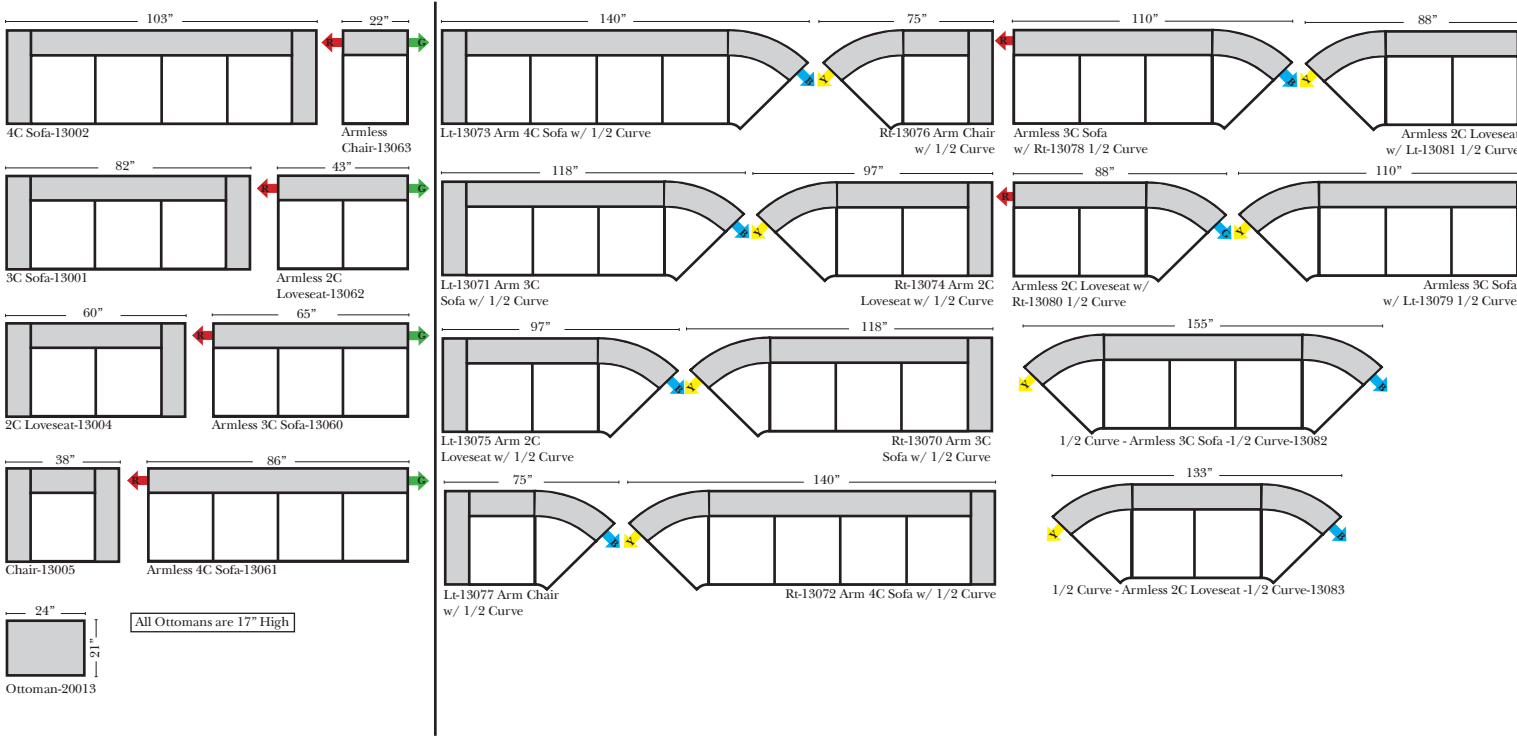

Specifications & Options

- Standard:**
- Available in Full & Top Grain Leathers
 - Available in Luxury Fabrics
 - All Hardwood Frames
 - Leg Color - Walnut
- Options Available with No Additional Charge:**
- Change Leg Color to: Cherry, Chocolate, Espresso, Honey Oak, & Shadow
 - No. 33 Firm Foam

Options that have Additional Charges:

- Add Down Seats & Backs

Sleeper Options : (Sleepers not available at this time)

N/A



Note:
All Dimensions are approximate, if accuracy is crucial, please contact us for validation of the dimensions shown. However, a 1" to 2" variance can still apply due to foam and upholstery.



L-Shape / 90 Degree Sectional

(All 4 seat items ship as one piece if stationary, two pieces if motion installed)

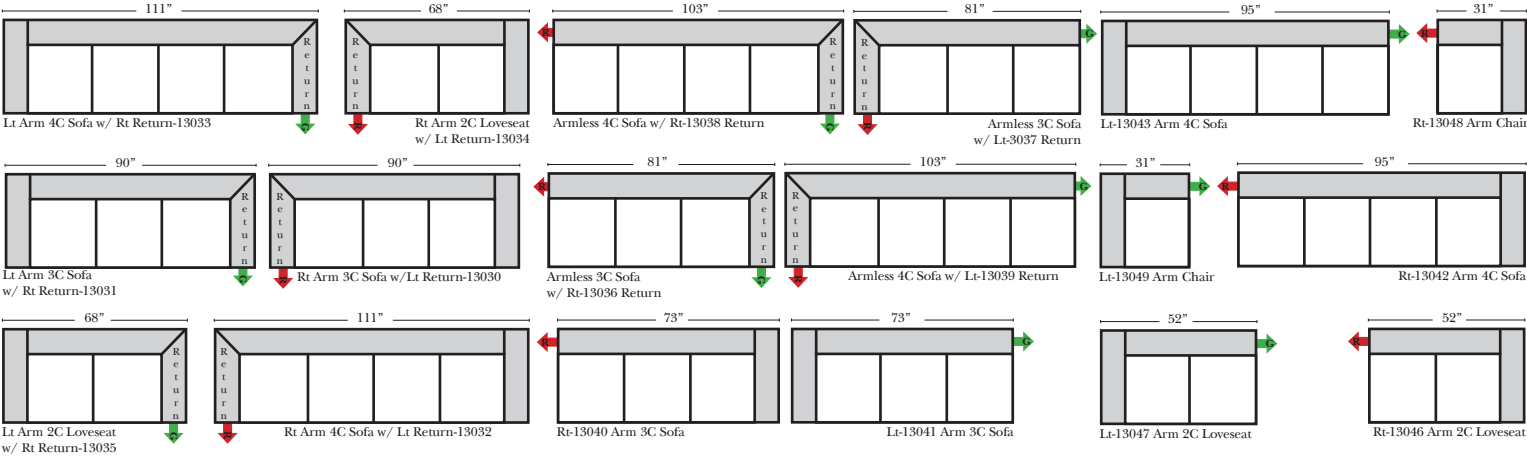
Put Green Arrows with Red Arrows to Create Sectional Groups → ←



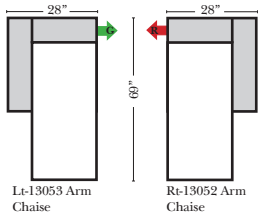

Chaise & Conversation Sectionals

Put Green Arrows with Red Arrows to Create Sectional Groups 
 Put Orange Arrows with Tan Arrows to Create Sectional Groups 



Conversation Sectionals
 for this style not available
 at this time

Sleepers

Put Green Arrows with Red Arrows to Create Sectional Groups 
 Put Blue Arrows with Yellow Arrows to Create Sectional Groups 

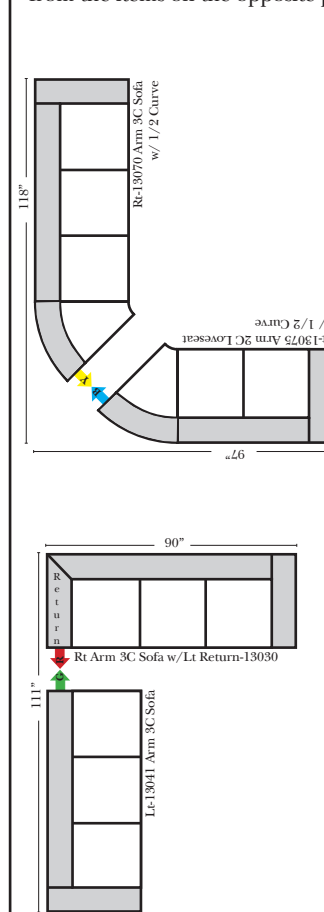

Sleepers
 for this style not available
 at this time

Suggested Configurations

The Suggested Configurations below are only a sample of what the imagination can create, please enjoy creating the configuration that fits your lifestyle, using the ideas below and from the items on the opposite page.

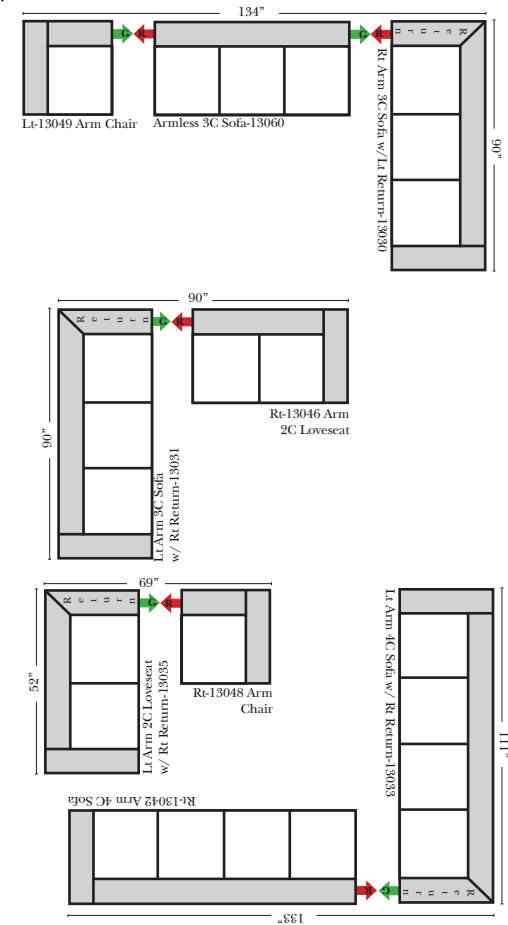

Sleepers (Cont.)